

Electrical protection unit with automatic reclosures, mains analysis, cutting-edge instrumentation, logging, input-output automation and control. Display, programming and control via WebServer over Internet/Intranet directly with Web browser + Integration into IoT platforms using TCP/IP HTTP Web Server commands
Multiple electrical protections upon very high-speed power failure, with built-in reclosure motor-drive



5PM: MCB from 6 to 63A, 2 and 4-pole (Icu 10-15kA)



Ultra-immunised differential protection

Información del equipo (V5.5 Jul 4 2022)			
Fecha - Hora: Lunes 04/07/22 16:24h			
Ubicación: Ninguna Alarma			
Estado alarma: OK, Power OK, LINES 04/07/22 11:50h			
Última alarma: Falto, energía Vac Off Lines 04/07/22 11:03h			
Última desconexión: No hay información.			
PIN		RESET	
Medidas			
Tensión RMS		Tensión entre fases	
V L1 = 240.77	V L2 = 240.96	V L12 = 414.87	V L13 = 416.03
V L3 = 239.39	V Ph L1 = 316.96	V L23 = 416.03	V L1 = 408.46
Intensidad RMS		Intensidad Neutra	
A L1 = 7.36	A L2 = 6.08	A LN = 8.29	mA = 292.4
A L3 = 14.70	A Ph L1 = 22.14		mA Ph = 475.0
Desbalance tensión		THD tensión	
% L1 = 11.4	% L2 = 11.5	% L1 = 1.8	% L2 = 1.8
% L3 = 22.9	% L3 = 2.1	% L1 = 1.8	% L2 = 1.8
Factor de potencia tensión		Factor de potencia intensidad	
PF L1 = 0.952	PF L2 = 0.946	PF L1 = 0.952	PF L2 = 0.946
PF L3 = 0.959	PF L3 = 0.959	PF L1 = 0.952	PF L2 = 0.946
Potencia Activa		Potencia Reactiva	
W L1 = 1774.2	W L2 = 1468.3	W L1 = 1695.3	W L2 = 1419.5
W L3 = 2399.4	W L3 = 4225.1	W L3 = 2052.9	W L3 = 9.8
ΣL123 = 6429.0	ΣL123 = 6242.4	ΣL123 = 6377.3	ΣL123 = 14.7
Potencia Reactiva Inductiva		Potencia Reactiva Capacitiva	
VAR L1 = 0.0	VAR L2 = 0.0	VAR L1 = 0.0	VAR L2 = 0.0
VAR L3 = 891.2	VAR L3 = 891.2	VAR L1 = 0.0	VAR L2 = 0.0
Tensión DC		Intensidad DC	
Vdc L1 = 0.00	Vdc L2 = 0.01	Adc L1 = 0.00	Adc L2 = 0.00
Vdc L3 = 0.00		Adc L3 = 0.02	mAdc = 0.0

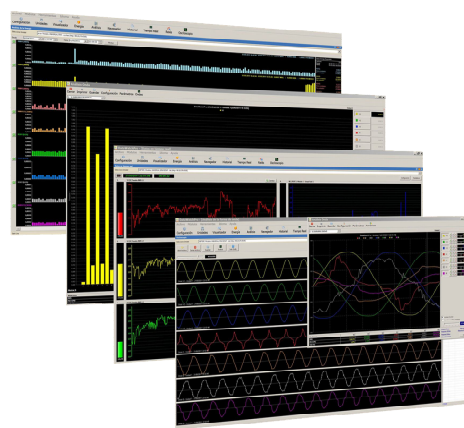

Other models

M2: MCB from 10 to 125A, 2 and 4-pole, automatic reclosure (Icu 50kA), or moulded-case circuit-breaker from 80 to 250A-2000A, 4-pole, with automatic reclosure
M5: Triggered by SHUNT TRIP or external MCB manual reclosure from 6 to 10000A, 2 and 4-pole. **M3:** External relay/contactors from 25 to 1250A, 2 and 4-pole with automatic reclosure.

Electrical protections/alarms, programmable in both value and delay, with automatic reclosures programmable in number, time and reset	Mains analysis, electrical RMS and Peak, metering
Differential intensity, RMS and Pk (type); $I_{\Delta n}$ 30-1000mA; Δt from 40ms to 1000ms	Intensidad diferencial RMS, Pk
Differential intensity: Versions 10-300mA, 30-1000mA, 100-3000mA	RMS snf Pk, voltage L1, L2, L3 ; RMS voltage phases L1-2, L2-3, L3-1
Overvoltage: RMS and Pk L1, L2, L3 and low voltage RMS L1, L2, L3	RMS and Pk intensity L1, L2, L3 and neuter intensity
Line over-intensity: RMS and Pk L1, L2, L3	Active power W L1, L2, L3, $\Sigma L123$
Neuter intensity	Apparent power L1, L2, L3, $\Sigma L123$
Power factor L1, L2, L3	Reactive, inductive and capacitive power L1, L2, L3, $\Sigma L123$
Voltage total harmonic distortion, THD L1, L2, L3. Harmonics 2 – 63	Voltage total harmonic distortion, THD L1, L2, L3. Harmonics 2 – 63
Intensity total harmonic distortion, THD L1, L2, L3. Harmonics 2 – 63	Intensity total harmonic distortion, THD L1, L2, L3. Harmonics 2 – 63
Phase sequence and phase failure L1, L2, L3	Requested and returned power L1, L2, L3, $\Sigma L123$
Voltage and intensity unbalance L1, L2, L3	Power factor L1, L2, L3
Over and low frequency L1, L2, L3	Active and reactive energy counters L1, L2, L3, $\Sigma L123$
Built to allow reconnection of the new digital counters	Line frequency and impedancia L1, L2, L3
Over and low temperature + over and low humidity	Voltage and intensity unbalance L1, L2, L3
Preventive cut-off upon AC power failure – insufficient power	Voltage and intensity crest factor L1, L2, L3
Remote input 1, Remote input 2. Programmable (ON/OFF and Reset reclosure)	Temperature, relative humidity
Cutting-edge instrumentation for electrical parameters in mains analysis	
7-channel oscilloscope with autoscale, offset control, amplitude, time base, advance/delay in degrees and measurement cursor. Multi-channel, RMS, Pk, THD, etc. metering	Voltage V1, Intensity I1, Voltage V2, Intensity I2 Voltage V3, Intensity I3, Differential intensity ID (display in DataWatchPro)
7-channel harmonics spectrum analysis with autoscale (63 harmonics, range in % and value V – A). Measurement cursor, multi-channel, simultaneous analysis of channels 1, 2, 3, 4, 5, 6 and 7	Voltage V1, Intensity I1, Voltage V2, Intensity I2 Voltage V3, Intensity I3, Differential intensity ID (display in DataWatchPro)
Module: graphic analysis of energy	Display in DataWatchPro
Module: real time	Display in DataWatchPro
Module: graphic plotter (graphic long period analysis)	Display in DataWatchPro
Module: Graphic display (rapid analysis)	Display in DataWatchPro
Module: daily analysis	Display in DataWatchPro
Log	
Historic LOG, ON/OFF log and alarm information	Chronological log of alarms, cut-off/reset, failure/start-up of electrical supply Year, month, day, hour and minute measurement values
Individual MCB cut-off counters	45 independent counters, counting from 0 to 9999
Maximum measurements logs	37 independent logs
Minimum measurements logs	8 independent logs
Chronological log of most recent cut-off and most recent alarm	Year, month, day, hour and minute measurement values
Automation and input/output control (10 logic outputs [relays] and 10 logic inputs)	
Programmable enablement/disablement of 10 relays	Upon one or various alarms, reclosure blocking, internal time programmer, 8 timers
Manual enablement/disablement of outputs	10 logic outputs (relays)
Monitoring of inputs	10 logic inputs
Time programmer	Weekly, 6 programmes/day
Programmable enablement/disablement of 10 relays (DataWatchPro software)	Programmable automation of relays with level alarms in a time-frame for each unit
High safety (The 230V units withstand overvoltages of 425V permanent and 1000V PK)	
Very high-speed cut-off of the MCB	2ms 2-pole, 5ms 4-pole
Real, incremental, manual and automatic differential intensity test, + autotest	Automatic prior to reclosure...Real, conclusive differential tester..
Double cut-off device for MCB	Energy storage which permits MCB cut-off, even without power
Programming protected by security code, default configuration ex-factory, acoustic warnings, configurable in English or Spanish	
Standards: EN 60947-2 (anexo B):2018, UNE 20-600-77, EN 50550:2011 (consult manual)	
Technical mechanical endurance Safeline reclosure module: 100,000 complete ON OFF manoeuvres, Measurement precision 0,5% (V, I). 3-year guarantee	

Display directly with Web browser via Internet/Intranet, with no need for software

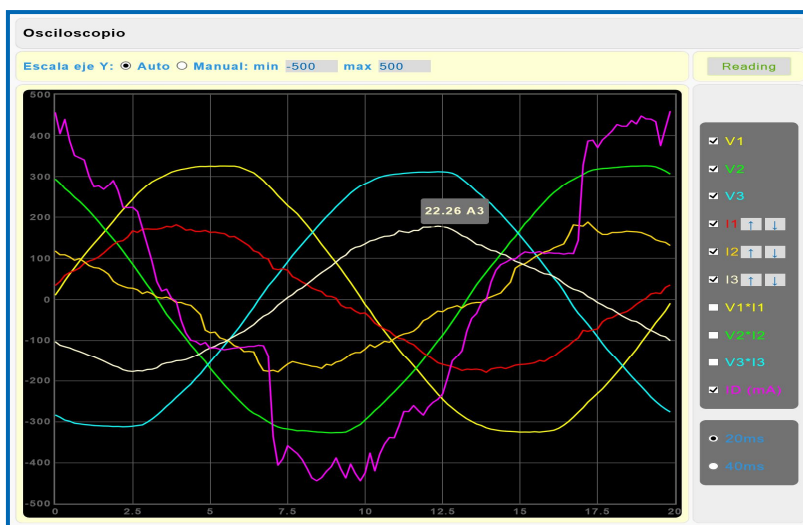
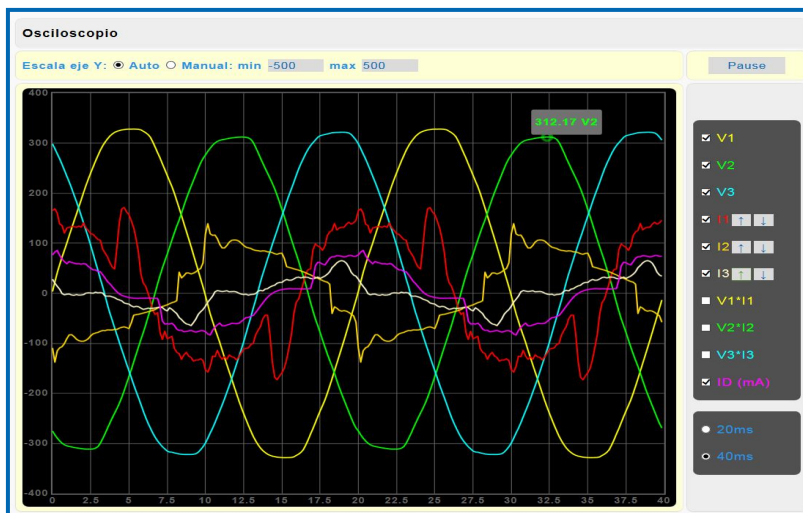

Información del equipo (V5.5 Jul 4 2022)			
Fecha - Hora:	Lunes 04/07/22 19:24h		
Posición motor:	ON		
Estado alarma:	Ninguna Alarma		
Estado actual:	OK, Power ON Lunes 04/07/22 11:15h		
Ultima alarma:	Fallo, energia Vac OFF Lunes 04/07/22 11:03h		
Ultima desconexión:	No hay informacion...		
PIN <input type="button" value="RESET"/>			
Medidas			
Tensión RMS	Tensión Pk	Tensión entre fases	Frecuencia
V L1 = 240.77	VPk L1 = 332.66	V L12 = 414.87	Hz L1 = 50.0
V L2 = 240.96	VPk L2 = 333.06	V L23 = 410.03	Hz L2 = 50.0
V L3 = 230.39	VPk L3 = 316.90	V L31 = 408.46	Hz L3 = 50.0
Intensidad RMS	Intensidad Pk	Intensidad Neutro	I. Diferencial RMS y Pk
A L1 = 7.36	APk L1 = 11.04	A LN = 8.29	mA = 292.4
A L2 = 6.08	APk L2 = 10.66		mAPk = 475.0
A L3 = 14.70	APk L3 = 22.14		
Desequilibrio tensión	THD tensión	Desequilibrio intensidad	THD intensidad
% L1 = +1.4	% L1 = 1.8	% L1 = +21.5	% L1 = 7.8
% L2 = +1.5	% L2 = 2.0	% L2 = +35.1	% L2 = 17.5
% L3 = +2.9	% L3 = 2.1	% L3 = +56.7	% L3 = 10.1
Factor de cresta tensión	Factor de cresta intensidad	Impedancia	Temperatura y Humedad
L1 = 1.381	L1 = 1.499	Z L1 = 32.71	%RH = +32.5
L2 = 1.382	L2 = 1.753	Z L2 = 39.63	
L3 = 1.375	L3 = 1.505	Z L3 = 15.67	
Potencia Aparente	Potencia Activa	Potencia solicitada	Potencia retornada
VA L1 = 1774.2	W L1 = +1691.3	W L1 = 1695.3	W- L1 = 3.9
VA L2 = 1466.3	W L2 = +1418.0	W L2 = 1419.1	W- L2 = 1.0
VA L3 = 3389.4	W L3 = +3253.1	W L3 = 3262.9	W- L3 = 9.8
ΣL123 = 6629.9	ΣL123 = 6362.4	ΣL123 = 6377.3	ΣL123 = 14.7
Potencia Reactiva Inductiva	Potencia Reactiva Capacitiva	Factor de Potencia	
VarL L1 = 0.0	VarC L1 = 535.8	PF L1 = 0.952	
VarL L2 = 0.0	VarC L2 = 373.2	PF L2 = 0.966	
VarL L3 = 951.2	VarC L3 = 0.0	PF L3 = 0.959	
ΣL123 = 951.2	ΣL123 = 909.0		
Tensión DC	Intensidad DC	Intensidad diferencial DC	
Vdc L1 = 0.00	Adc L1 = 0.00	mAdc = 0.0	
Vdc L2 = 0.01	Adc L2 = 0.00		
Vdc L3 = 0.00	Adc L3 = 0.02		

Contadores de energía			
Energía Activa		Energía Reactiva	
KWh L1 = 13.20302	KWh L2 = 13.93636	KQh L1 = 3.99019	KQh L2 = 2.04288
KWh L3 = 18.34288	ΣL123 = 45.48226	KQh L3 = 4.87873	ΣL123 = 10.91180
PIN <input type="button" value="RESET"/>			
Valores máximos medidos			
Tensión RMS	Intensidad RMS	Desequilibrio tensión	THD tensión
V L1 = 243.95	A L1 = 13.07	% L1 = +2.3	% L1 = 2.4
V L2 = 244.05	A L2 = 16.63	% L2 = +2.1	% L2 = 2.6
V L3 = 237.51	A L3 = 26.33	% L3 = +4.1	% L3 = 2.6
Desequilibrio intensidad	THD Intensidad	Intensidad Neutro	Intensidad diferencial RMS
% L1 = +102.6	% L1 = 11.0	A LN = 21.97	mA = 296.1
% L2 = +83.6	% L2 = 19.6		
% L3 = +93.1	% L3 = 151.6		
Potencia Aparente	Potencia Activa	Potencia Reactiva Inductiva	Potencia Reactiva Capacitiva
VA L1 = 3139.4	W L1 = 3106.6	VarL L1 = 312.2	VarC L1 = 648.4
VA L2 = 3914.4	W L2 = 3885.6	VarL L2 = 448.0	VarC L2 = 410.8
VA L3 = 5850.1	W L3 = 5355.3	VarL L3 = 3075.2	VarC L3 = 746.3
Temperatura y Humedad	Frecuencia		
%RH = 48.2	Hz L1 = 50.0		
	Hz L2 = 50.0		
	Hz L3 = 50.0		
PIN <input type="button" value="RESET"/>			
Valores mínimos medidos			
Tensión RMS	Frecuencia	Temperatura y Humedad	
V L1 = 235.37	Hz L1 = 49.9	%RH = +29.4	
V L2 = 234.91	Hz L2 = 49.9		
V L3 = 225.58	Hz L3 = 49.9	%RH = 36.7	
PIN <input type="button" value="RESET"/>			

Software Safeline Web Service V1.1.0 (dedicated server)

Administration and control software via Internet/Intranet for multiple Sureline Universal+ TWR units

Storage of measurement and I/O status data sent by the units

Unit register and geographical location management from map via Google Maps

Weekly astronomical programmer for each geographical location (output relays) assignable to groups of units

Thousands of independent hourly programmers (assignable to groups of units):

- Daily / weekly
- Daily / monthly / yearly
- Daily / monthly/ yearly (vacations and holidays)

Output relay management and logical input management

Graphical analysis of measurements

Management of measurement alarms and logical input for each unit, with notifications via e-mail

Unit management by labels. Attribute search engine.

Auto-register of units in the server

Administration capacity: 16000 Sureline units. Configurable in English or Spanish

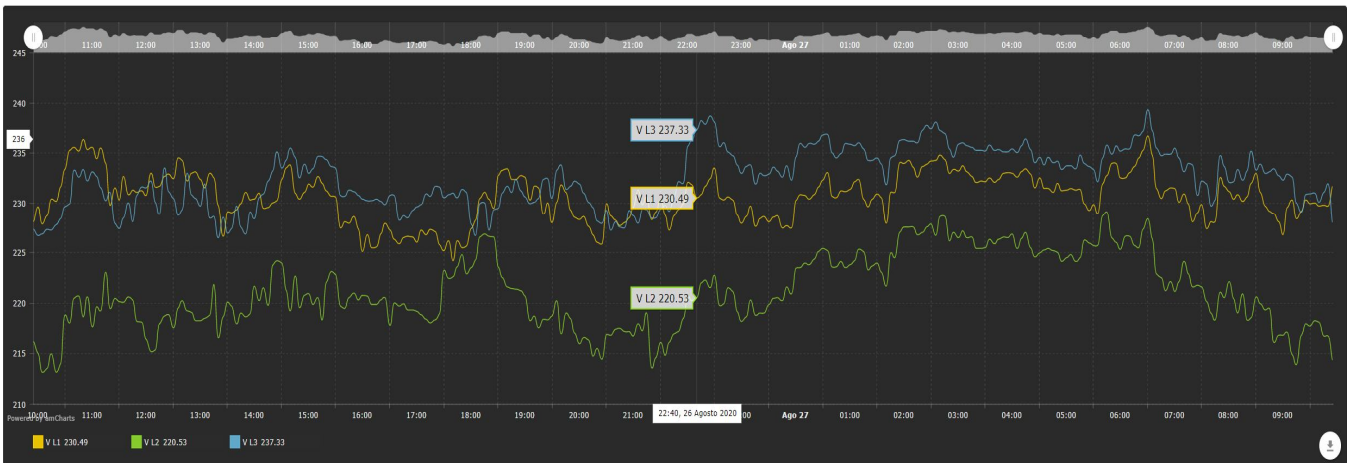

Tema: Dark | Cursor: Zoom | Visualizador: Líneas suavizadas

Promediados:

Series	Max	Min	Avg
V L1	236.66	224.21	230.58
V L2	229.06	213.15	221.14
V L3	239.28	226.47	232.42

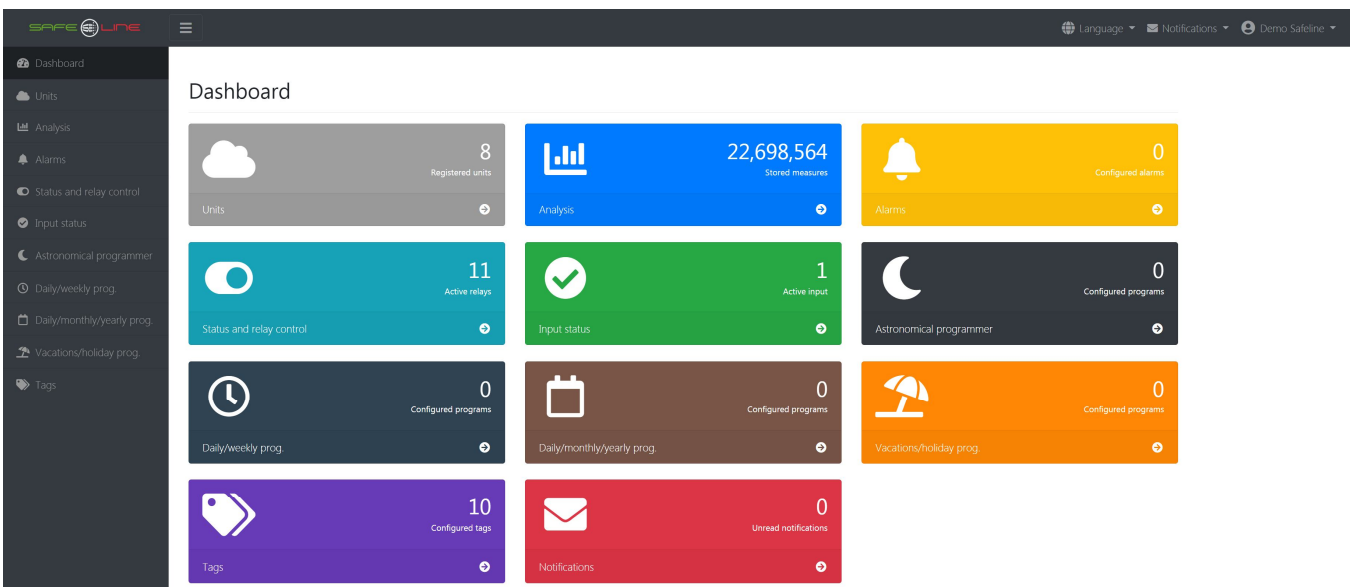

SAFE LINE

Language | Notifications | Demo Safeline

Dashboard

Units: 8 Registered units	Analysis: 22,698,564 Stored measures	Alarms: 0 Configured alarms
Status and relay control: 11 Active relays	Input status: 1 Active input	Astronomical programmer: 0 Configured programs
Daily/weekly prog: 0 Configured programs	Daily/monthly/yearly prog: 0 Configured programs	Vacations/holiday prog: 0 Configured programs
Tags: 10 Configured tags	Notifications: 0 Unread notifications	

IMAGES DataWatchPro.

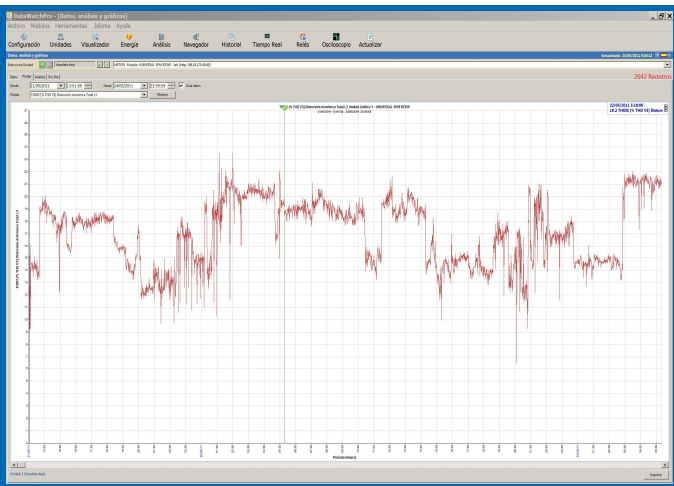
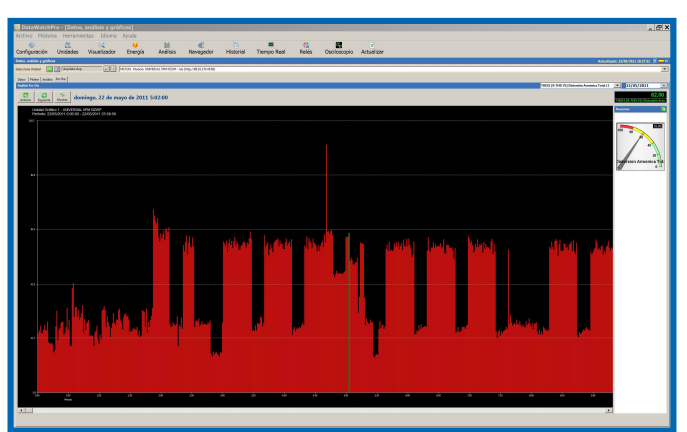
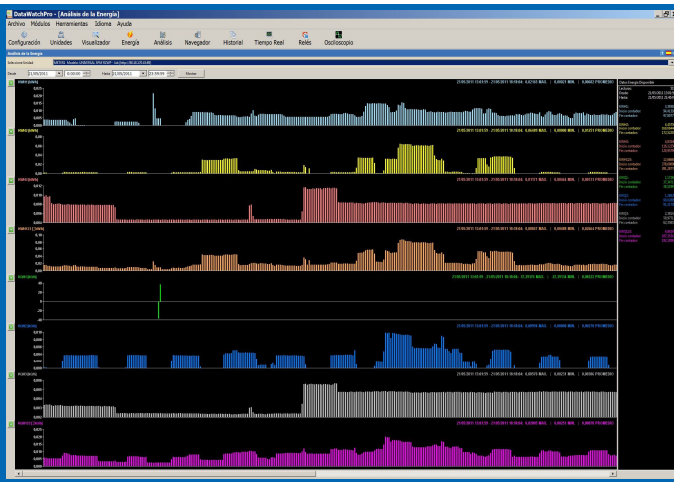
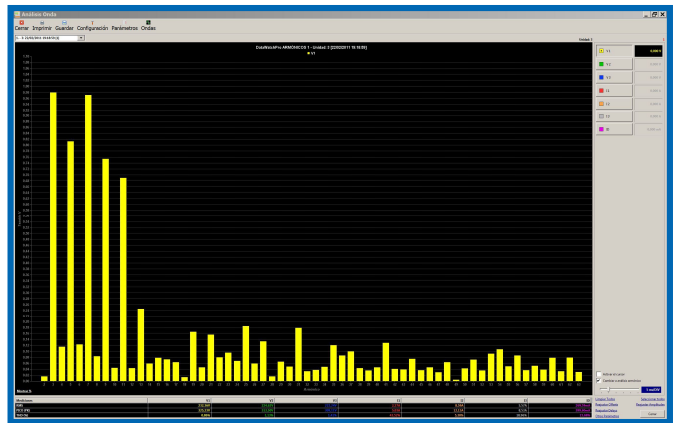
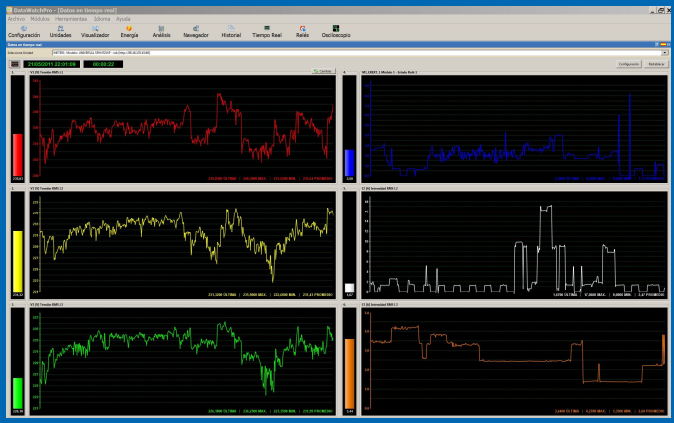
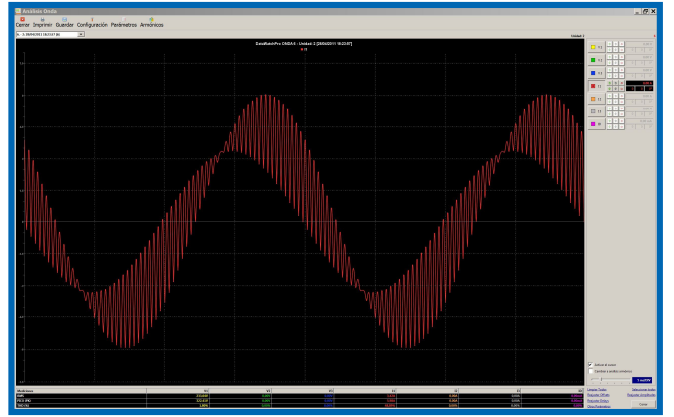
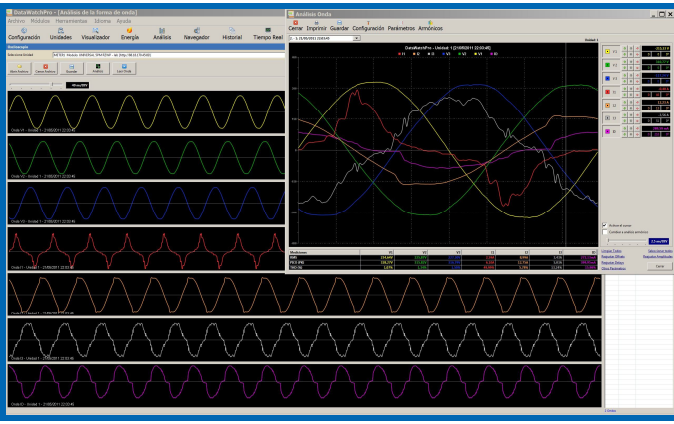

This screenshot shows the 'Configuración' (Configuration) window for relays. It includes a table of relay settings and a 'Crear Comandos ON / OFF' (Create ON / OFF Commands) dialog box.

Relé	Nombre	Parámetro	Valor	Dimensión	MAX/MIN	ON (1) - OFF (0)
Relé 1	Relé 1	Relé 1	20000	mA	MAX	ON (1)
Relé 2	Relé 2	Relé 2	20000	mA	MAX	ON (1)
Relé 3	Relé 3	Relé 3	20000	mA	MAX	ON (1)
Relé 4	Relé 4	Relé 4	20000	mA	MAX	ON (1)
Relé 5	Relé 5	Relé 5	20000	mA	MAX	ON (1)
Relé 6	Relé 6	Relé 6	20000	mA	MAX	ON (1)
Relé 7	Relé 7	Relé 7	20000	mA	MAX	ON (1)
Relé 8	Relé 8	Relé 8	20000	mA	MAX	ON (1)
Relé 9	Relé 9	Relé 9	20000	mA	MAX	ON (1)
Relé 10	Relé 10	Relé 10	20000	mA	MAX	ON (1)
Relé 11	Relé 11	Relé 11	20000	mA	MAX	ON (1)
Relé 12	Relé 12	Relé 12	20000	mA	MAX	ON (1)
Relé 13	Relé 13	Relé 13	20000	mA	MAX	ON (1)
Relé 14	Relé 14	Relé 14	20000	mA	MAX	ON (1)
Relé 15	Relé 15	Relé 15	20000	mA	MAX	ON (1)

The 'Crear Comandos ON / OFF' dialog box shows the following settings:

- De día a noche: Mañana
- Hora de inicio: 00:00
- Hora finalización: 18:59
- Parámetro: [D]A Intensidad de consumo BAS
- Valor alarma: 90.50
- ON u OFF: ON (1) / OFF (0)
- Tipo de alarma: MAX / MIN

Buttons: 'Ejecutar', 'Cancelar', 'Guardar'.

DataWatchPro - Professional software with database and graphic data analysis

- Multi-thread communication with a multitude of remote units via Internet/Intranet (reading and command)
- 200-parameter chronological logger in database for each unit.
- Independent notifications via e-mail of 249 programmable alarms for each unit
- Programmable automation/tele-control of relays with level alarms in time frame for each unit
- Module: numerical data analysis
- Module: graphic data analysis
- Module: history analysis
- Configurable in English or Spanish

- Module: real time

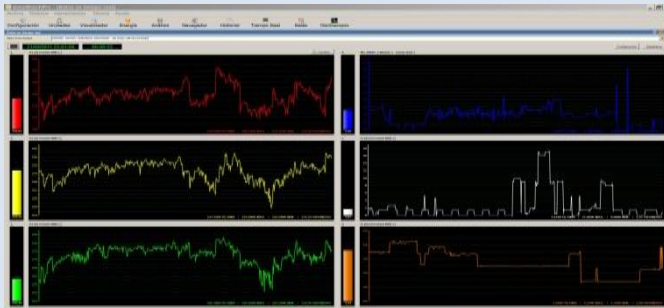

- Module: graphic energy analysis

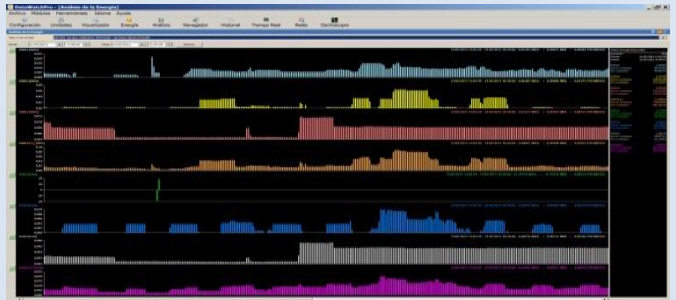

- Module: graphic plotter (graphic long period analysis)

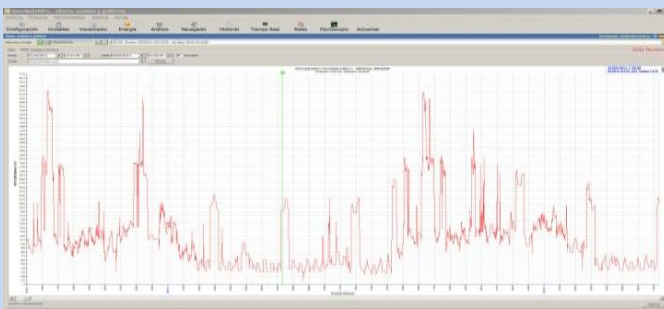

- Module: graphic display (rapid analysis)

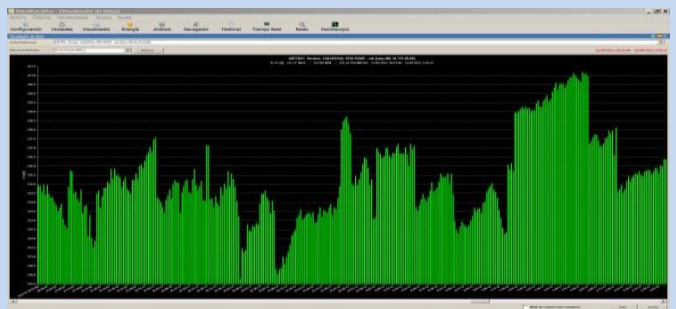

- Module: 7-channel oscilloscope. With autoscale and functions.



- Module: daily analysis.

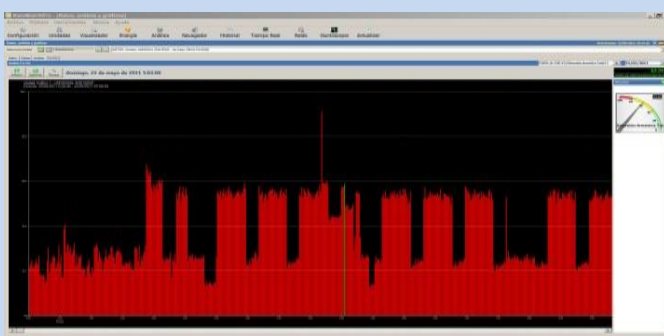

- Module: 7-channel harmonics spectrum. with autoscale (63 harmonics, range in % and value V-A)

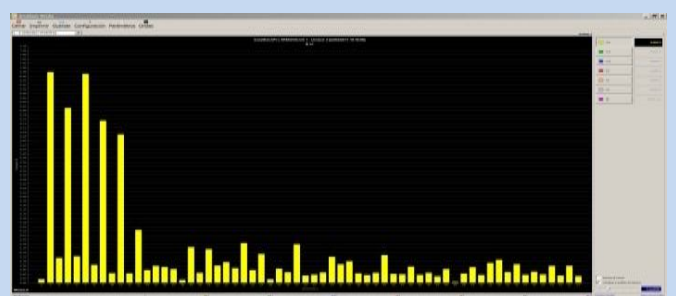

Wiring diagrams

MODELO UNIVERSAL+ 7WR 5PM M

CONFIGURACION MONOFASICA 2 POLOS 6, 10, 16, 20, 25, 32, 40, 50, 63A.



VERSION INTENSIDAD
DIFERENCIAL TIPO A

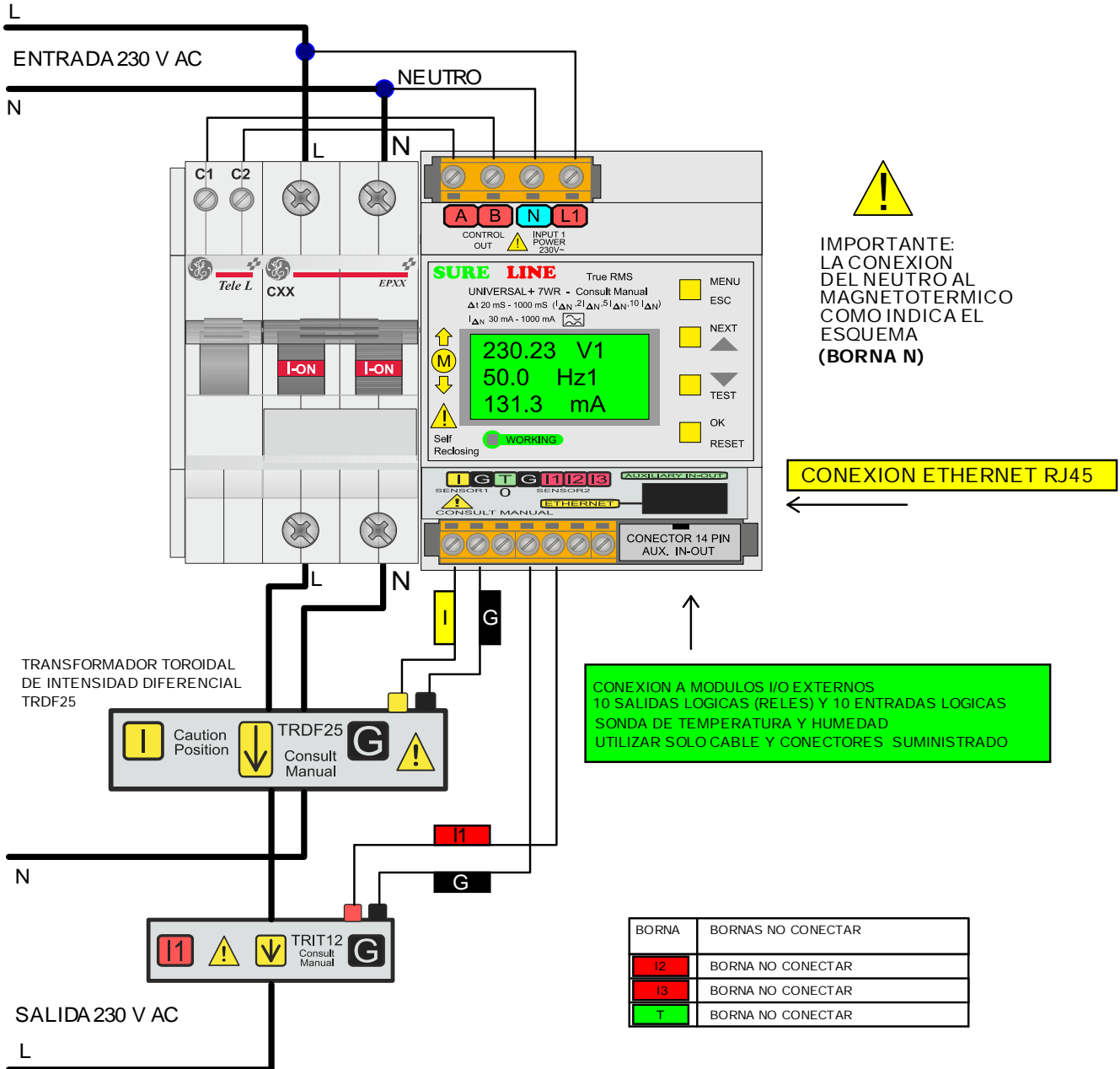

!

IMPORTANTE:
LA CONEXION
DEL NEUTRO AL
MAGNETOTERMICO
COMO INDICA EL
ESQUEMA
(BORNA N)

CONEXION ETHERNET RJ45

CONEXION A MODULOS I/O EXTERNOS
10 SALIDAS LOGICAS (RELES) Y 10 ENTRADAS LOGICAS
SONDA DE TEMPERATURA Y HUMEDAD
UTILIZAR SOLO CABLE Y CONECTORES SUMINISTRADO

BORNA	BORNAS NO CONECTAR
I2	BORNA NO CONECTAR
I3	BORNA NO CONECTAR
T	BORNA NO CONECTAR

TRDF25:
TRANSFORMADOR TOROIDAL DE INTENSIDAD DIFERENCIAL
PASAR LOS CONDUCTORES FASE (L) Y NEUTRO (N)
POR EL ORIFICIO DEL TRANSFORMADOR TOROIDAL
CALIBRADO PARA SU MODULO NO INTERCAMBIAR

TRIT12:
TRANSFORMADOR TOROIDAL DE INTENSIDAD DE LINEA
PASAR EL CONDUCTOR DE LINEA POR EL ORIFICIO
DEL TRANSFORMADOR. CALIBRADO PARA SU LINEA
Y MODULO NO INTERCAMBIAR

! CONSULTAR MANUAL DE INSTRUCCIONES

MODELO UNIVERSAL+ 7WR 5PM M

CONFIGURACION MONOFASICA 2 POLOS 6, 10, 16, 20, 25, 32, 40, 50, 63A.

VERSION CON 2 RELÉS A Y B DE SALIDA Y ENTRADA DE CONTROL REMOTE IN1

VERSION CON 1 RELÉ A DE SALIDA Y ENTRADA DE CONTROL REMOTE IN1



VERSION INTENSIDAD DIFERENCIAL TIPO A

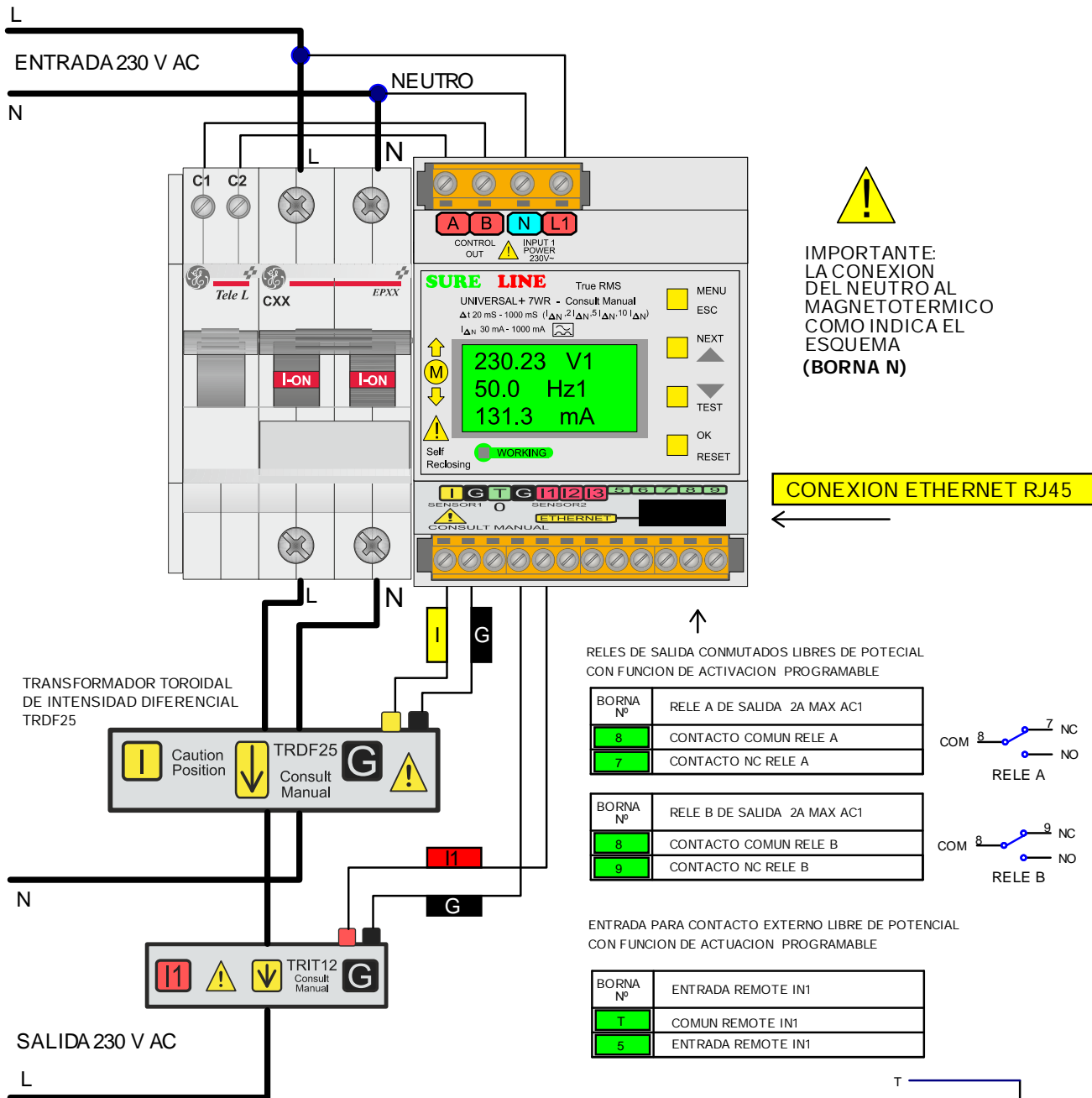

IMPORTANTE:
LA CONEXION DEL NEUTRO AL MAGNETOTERMICO COMO INDICA EL ESQUEMA (BORNA N)

CONEXION ETHERNET RJ45

RELES DE SALIDA CONMUTADOS LIBRES DE POTENCIAL CON FUNCION DE ACTIVACION PROGRAMABLE

BORNA Nº	RELE A DE SALIDA 2A MAX AC1
8	CONTACTO COMUN RELE A
7	CONTACTO NC RELE A



BORNA Nº	RELE B DE SALIDA 2A MAX AC1
8	CONTACTO COMUN RELE B
9	CONTACTO NC RELE B

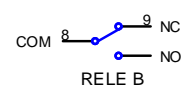

ENTRADA PARA CONTACTO EXTERNO LIBRE DE POTENCIAL CON FUNCION DE ACTUACION PROGRAMABLE

BORNA Nº	ENTRADA REMOTE IN1
T	COMUN REMOTE IN1
5	ENTRADA REMOTE IN1

S1 CONTACTO LIBRE DE POTENCIAL EXTERNO PARA ORDEN EXTERNA DEL REMOTE IN1

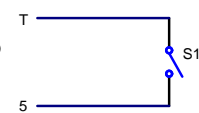

TRDF25:
TRANSFORMADOR TOROIDAL DE INTENSIDAD DIFERENCIAL PASAR LOS CONDUCTORES FASE (L) Y NEUTRO (N) POR EL ORIFICIO DEL TRANSFORMADOR TOROIDAL CALIBRADO PARA SU MODULO NO INTERCAMBIAR

TRIT12:
TRANSFORMADOR TOROIDAL DE INTENSIDAD DE LINEA PASAR EL CONDUCTOR DE LINEA POR EL ORIFICIO DEL TRANSFORMADOR. CALIBRADO PARA SU LINEA Y MODULO NO INTERCAMBIAR

BORNA	BORNAS NO CONECTAR
12	BORNA NO CONECTAR
13	BORNA NO CONECTAR
6	BORNA NO CONECTAR



CONSULTAR MANUAL DE INSTRUCCIONES

MODELO UNIVERSAL+ 7WR 5PM T

CONFIGURACION TRIFASICA 4 POLOS 6, 10, 16, 20, 25, 32, 40, 50, 63A.



VERSION INTENSIDAD
DIFERENCIAL TIPO A

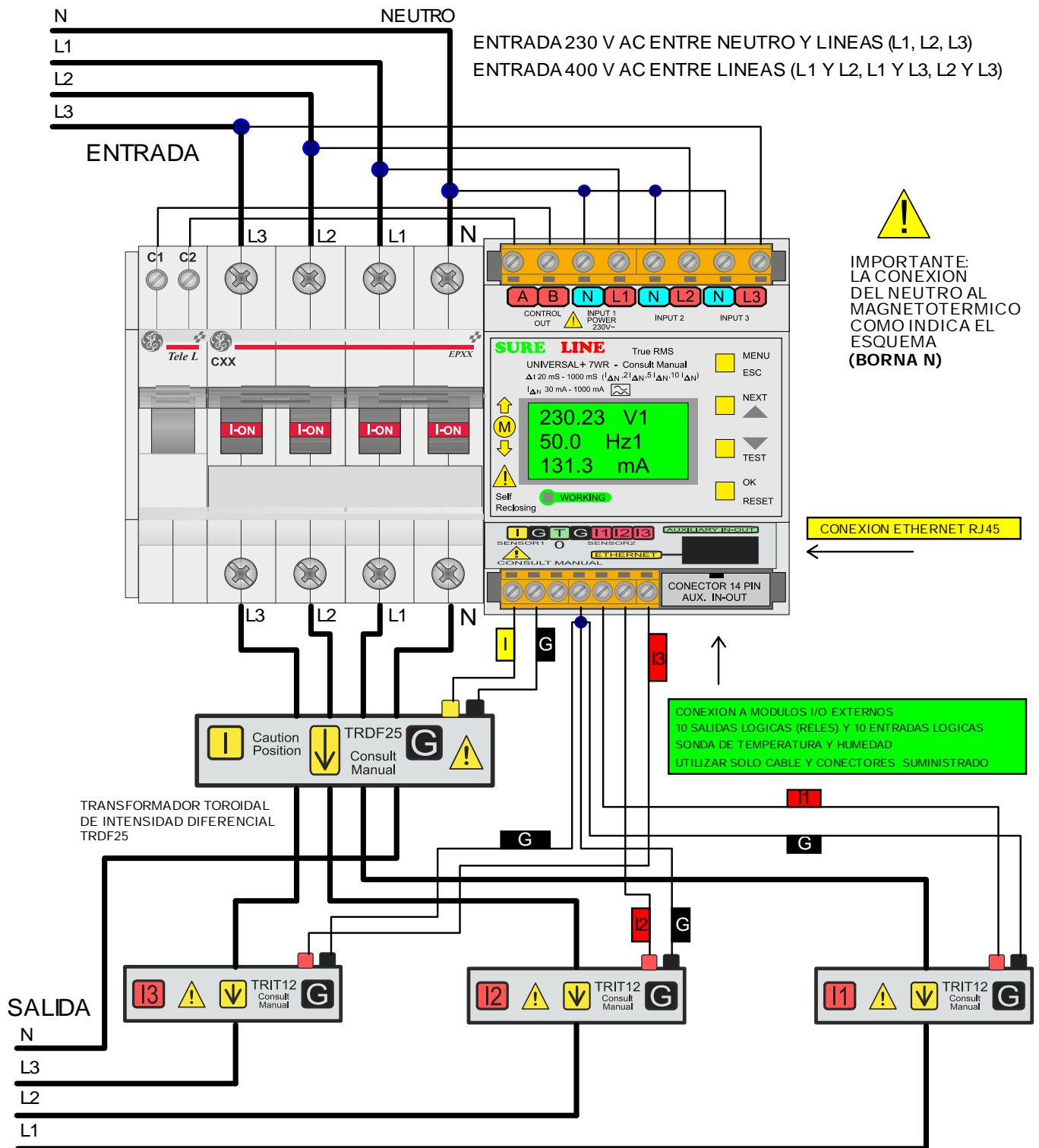

!
IMPORTANTE:
LA CONEXION
DEL NEUTRO AL
MAGNETOTERMICO
COMO INDICA EL
ESQUEMA
(BORNA N)

TRDF25:
TRANSFORMADOR TOROIDAL DE INTENSIDAD DIFERENCIAL
PASAR LOS CONDUCTORES FASE (L) Y NEUTRO (N)
POR EL ORIFICIO DEL TRANSFORMADOR TOROIDAL
CALIBRADO PARA SU MODULO NO INTERCAMBIAR

TRIT12:
TRANSFORMADOR TOROIDAL DE INTENSIDAD DE LINEA
PASAR EL CONDUCTOR DE LINEA POR EL ORIFICIO
DEL TRANSFORMADOR. CALIBRADO PARA SU LINEA
Y MODULO NO INTERCAMBIAR



CONSULTAR MANUAL DE INSTRUCCIONES

MODELO UNIVERSAL+ 7WR 5PM T

CONFIGURACION TRIFASICA 4 POLOS 6, 10, 16, 20, 25, 32, 40, 50, 63A

VERSION CON 2 RELÉS A Y B DE SALIDA Y ENTRADA DE CONTROL REMOTE IN1

VERSION CON 1 RELÉ A DE SALIDA Y ENTRADA DE CONTROL REMOTE IN1



VERSION INTENSIDAD
DIFERENCIAL TIPO A

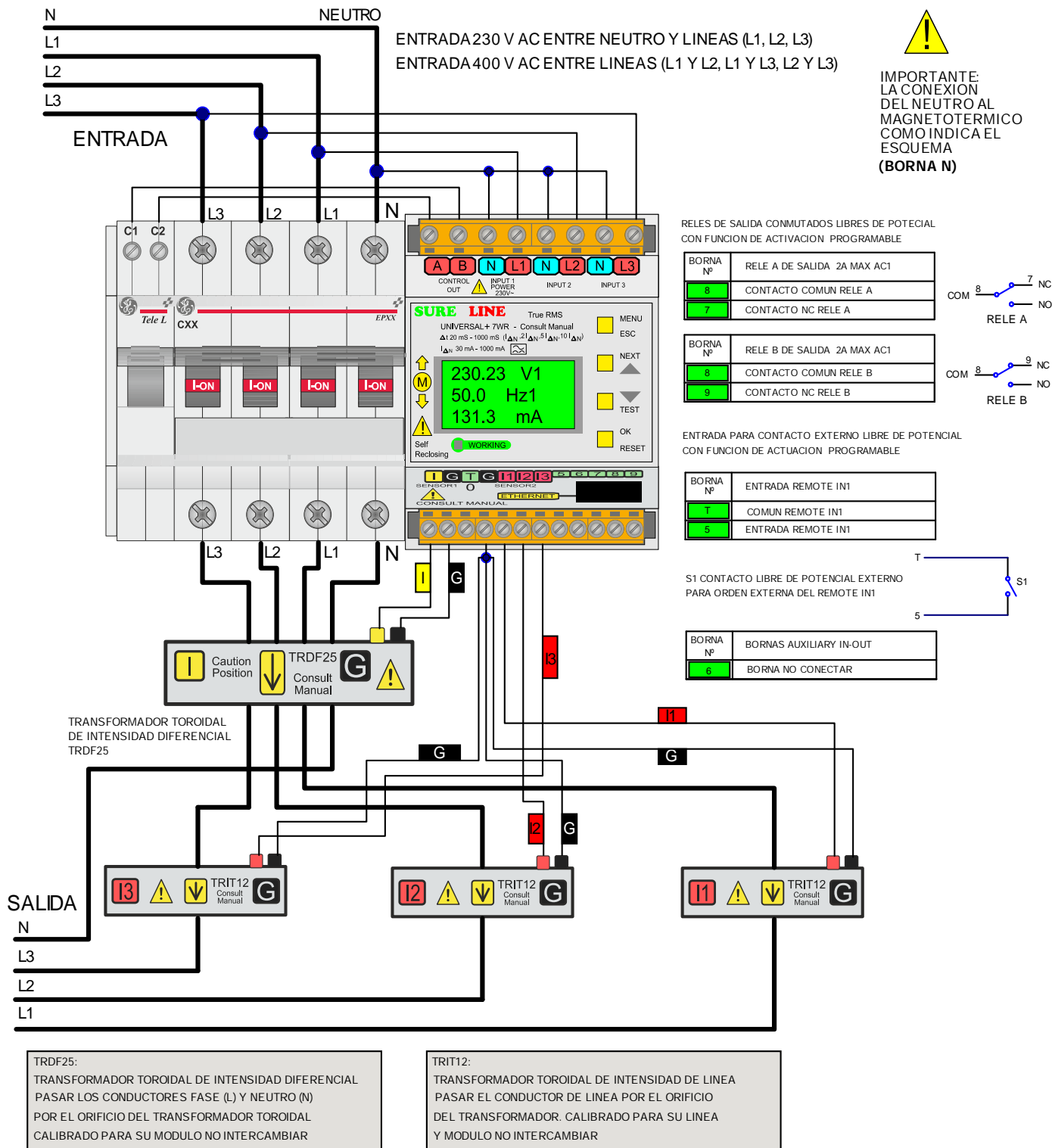

!
IMPORTANTE:
 LA CONEXION
 DEL NEUTRO AL
 MAGNETOTERMICO
 COMO INDICA EL
 ESQUEMA
 (BORNA N)

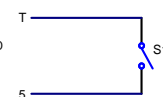
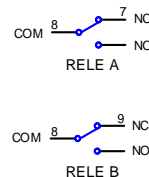

CONSULTAR MANUAL DE INSTRUCCIONES

UNIDAD UNIVERSAL 5PM (MONOFÁSICO / TRIFÁSICO)

EJEMPLO CONEXIÓN MODULOS DE RELÉS Y ENTRADAS LOGICAS

GREEN IN-OUT L Y GREEN IN-OUT C

10 RELES RELÉS DE SALIDA Y 10 ENTRADAS LOGICAS

GREEN IN-OUT L M1

5 RELES DE SALIDA Y 5 ENTRADAS LOGICAS

RELES DE SALIDA LIBRES DE POTEAL M1 (MODULO1)

BORNA Nº	BORNAS RELES OUT RELE A, 1, 2, 3, 4 6A MAX AC1
1	CONTACTO COMUN RELE A
2	CONTACTO N/O RELE A
3	CONTACTO COMUN RELE 1 y 2
4	CONTACTO N/O RELE 1
5	CONTACTO N/O RELE 2
6	CONTACTO COMUN RELE 3 y 4
7	CONTACTO N/O RELE 3
8	CONTACTO N/C RELE 4

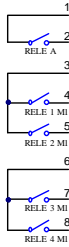

ENTRADAS M1 (MODULO1)

BORNA	BORNAS INPUT
A	COMUN INPUT
B	INPUT REMOTE IN1
C	INPUT IN1
D	INPUT IN2
E	INPUT IN3
F	INPUT IN4

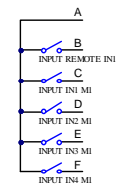

GREEN IN-OUT C M2

5 RELES DE SALIDA Y 5 ENTRADAS LOGICAS

RELES DE SALIDA LIBRES DE POTEAL M2 (MODULO2)

BORNA Nº	BORNAS RELES OUT RELE A, 1, 2, 3, 4 6A MAX AC1
1	CONTACTO COMUN RELE B
2	CONTACTO N/O RELE B
3	CONTACTO COMUN RELE 1 y 2
4	CONTACTO N/O RELE 1
5	CONTACTO N/O RELE 2
6	CONTACTO COMUN RELE 3 y 4
7	CONTACTO N/O RELE 3
8	CONTACTO N/C RELE 4

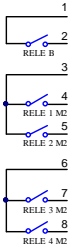

ENTRADAS M2 (MODULO2)

BORNA	BORNAS INPUT
A	COMUN INPUT
B	INPUT REMOTE IN2
C	INPUT IN1
D	INPUT IN2
E	INPUT IN3
F	INPUT IN4

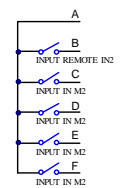

5 RELES DE SALIDA LIBRES DE POTEAL M1

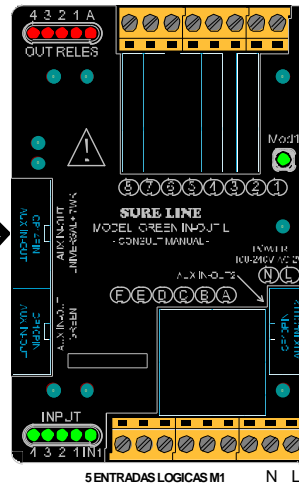

5 RELES DE SALIDA LIBRES DE POTEAL M2

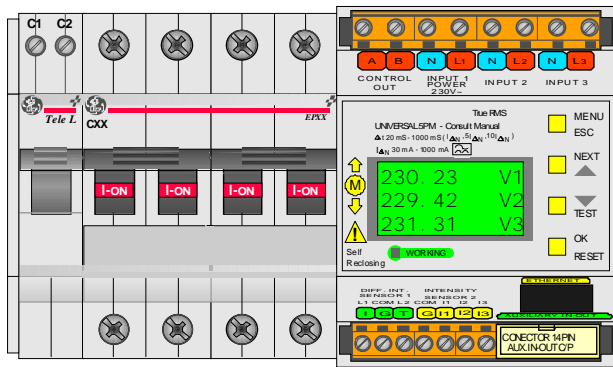
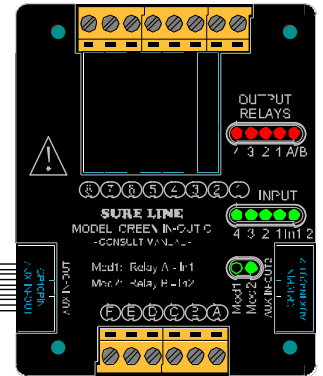

CONEXION ETHERNET RJ45

CONEXION MODULOS IO EXTERNOS UTILIZAR SOLO CONECTOR SUMINISTRADO

CONEXION MODULOS IO EXTERNOS UTILIZAR SOLO CONECTOR SUMINISTRADO

ALIMENTACIÓN AUXILIAR 100 - 240V AC 50/60Hz



CONSULTAR MANUAL DE INSTRUCCIONES

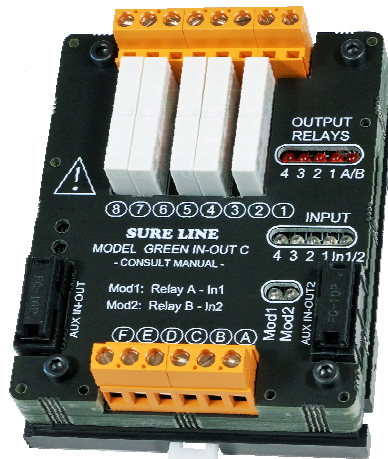

GREEN IN-OUT C PARA CARRIL DIN

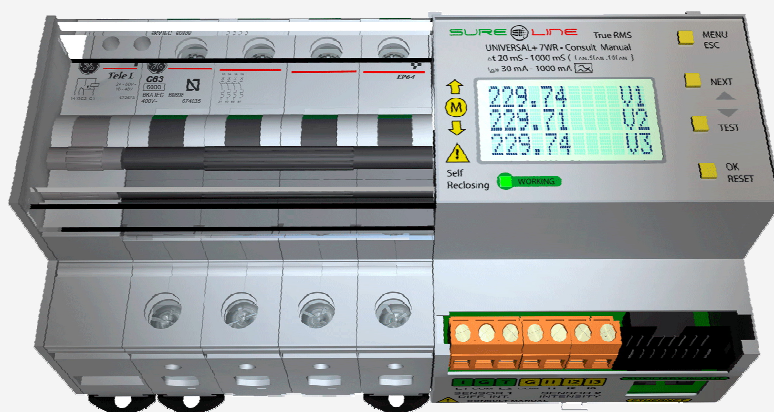
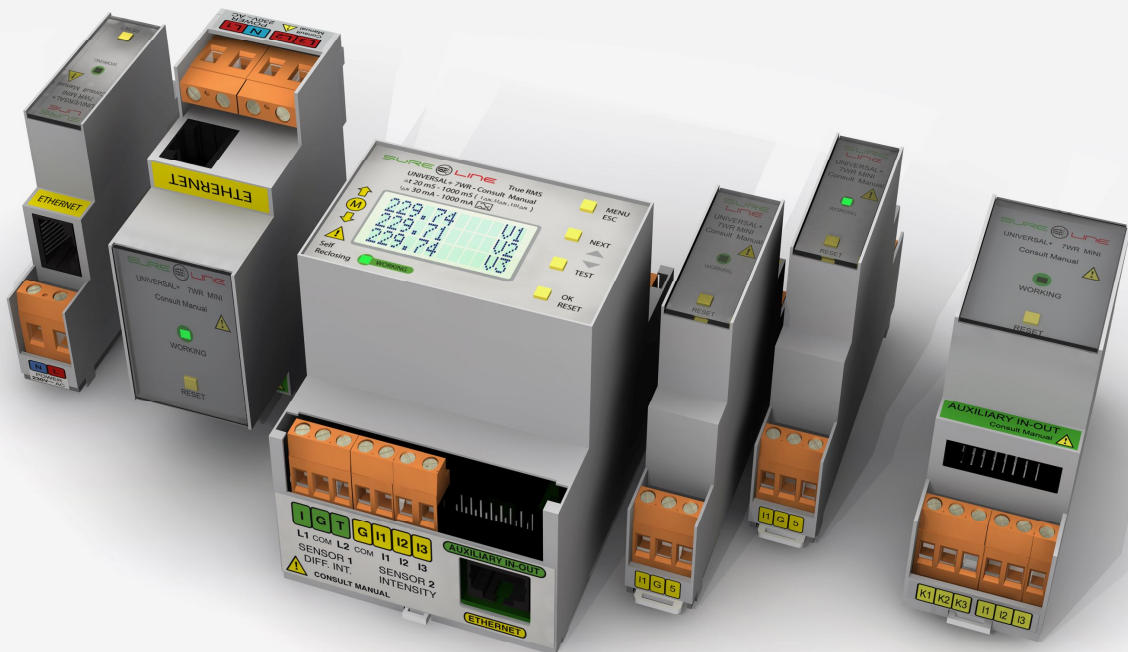

SAFELINE, S.L.

Edificio Safeline
Cooperativa, 24
E 08302 MATARO
(Barcelona) ESPAÑA
www.safeline.es
safeline@safeline.es

Comercial

T. +34 938841820
T. +34 937630801
comercial@safeline.es

Fábrica, I + D

T. +34 937630801
T. +34 607409841
inves@safeline.es

Administración

T. +34 937630801
T. +34 607409841
admin@safeline.es

Made in EU

